

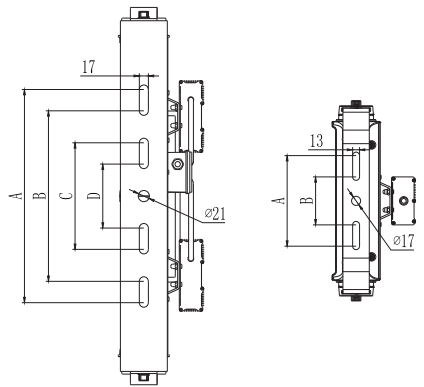

INSTALLATION INSTRUCTIONS

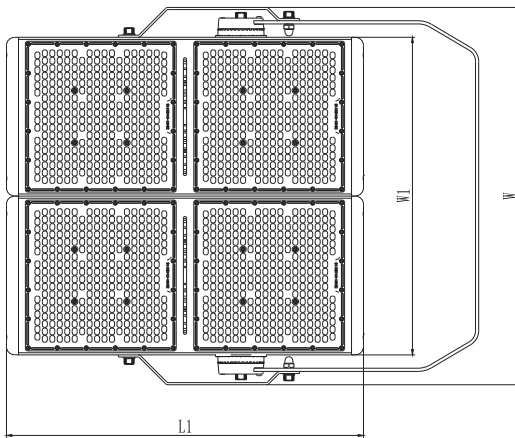

	400W/500W	800W	1200W	1600W	2400W
L	495mm	801mm	1116mm	886mm	1200mm
H1	90mm	90mm	90mm	90mm	90mm
H	157mm	160mm	160mm	160mm	160mm
L1	405mm	710mm	1025mm	710mm	1025mm
W1	298mm	298mm	298mm	596mm	596mm
W	375mm	391mm	391mm	708mm	708mm
A	170mm	170mm	170mm	400mm	400mm
B	90mm	90mm	90mm	320mm	320mm
C	—	—	—	200mm	200mm
D	—	—	—	120mm	120mm

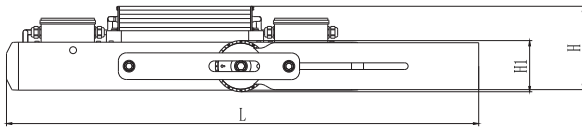
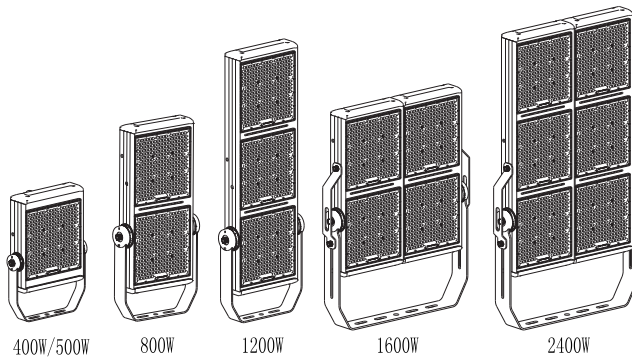

Flood Light Installation Parameters

Model No.	400W	500W	800W	1200W	1600W	2400W
Product Dimension	495*375*157 (mm)	495*375*157 (mm)	801*391*160 (mm)	1116*391*160 (mm)	886*708*160 (mm)	1200*708*160 (mm)
Luminaire Net Weight	11.5kg	11.5kg	19kg	28kg	41kg	54kg
Ingress Protection: IP66	IK Rating: IK10	Surge protecton: 20KV SPD (Standard)		Driver Brand: TOMCARLINE		
Driver Brand: TOMCARLINE	Input Voltage: AC200-240V/AC100-277V/AC277-480V		Power Factor: 0.95	Frequency: 47-63HZ		
Driver Type: Constant Current (CC)						
Finish: Powder coating	Fixture Color: Black	Mounting Option: Bracket installation			Warranty: 5 Years	
Ambient Temperature: -40~+45°C/-40~+50°C		Life Time: 50000 hours		Dimmable: 0-10V dimmable		
Material	Housing	Aluminum 6063-T5				
	Optics	PC Lens				
Efficiency Plus: 180±10lm/W(30°/60°/90°/110°*140°)			Efficiency: 140±10lm/W(10°/18°)			

1.Preparation and confirmation before installation

- 1) Be sure to take out all the accessory packages before installation, and remove the packaging accessories and tape on the lamp to avoid fire.
- 2) Determine whether the strength of the installation location can withstand the weight of the lamp and prevent the lamp from falling.
- 3) Please choose suitable installation accessories, such as bolts, wrenches.

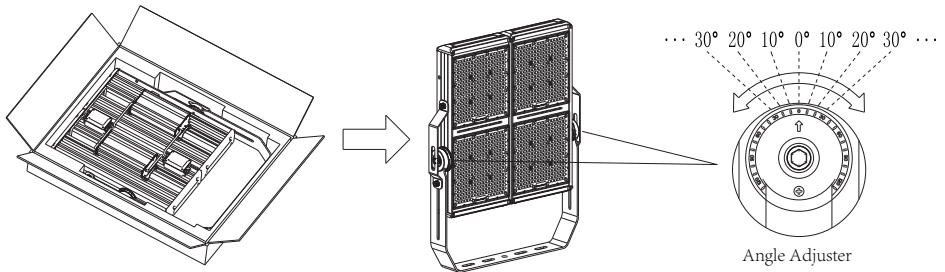

Choose the suitable wrenches, bolts and nuts.

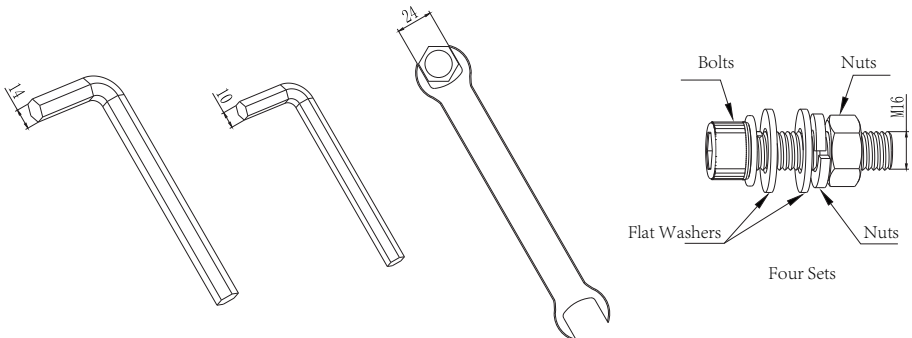

2. Bracket adjustment for positioning light distribution

- 1) Prepare the M10 Allen wrench.
- 2) Loosen the screw bolt.
- 3) Adjust the bracket to position the light distribution.
- 4) Tighten the screw bolt.

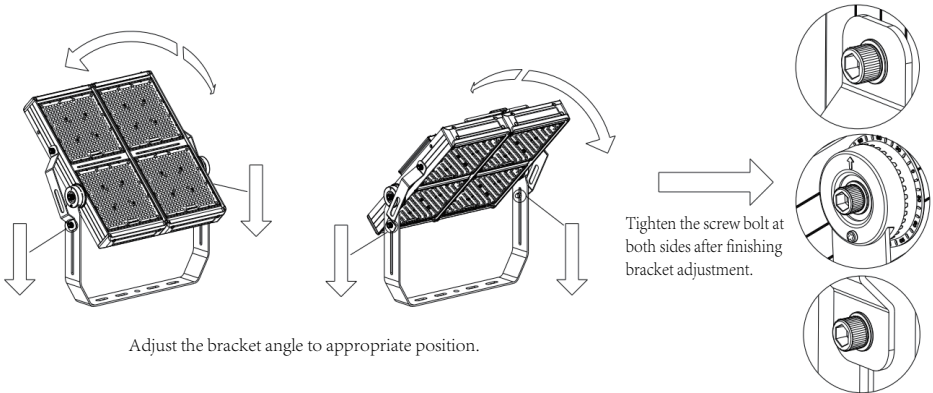
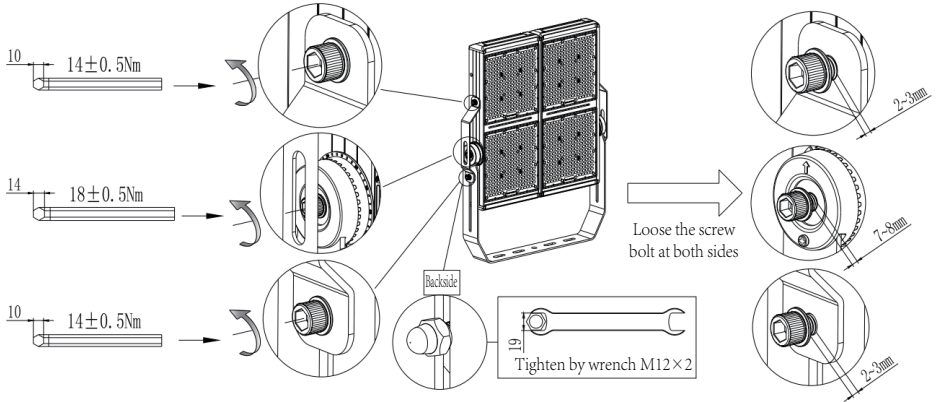

3. Installation Instruction of Whole Lamp and connection to the mains supply

- 1) Select the screw bolts of M16 with nuts, gaskets, etc.
- 2) Put the lamp in a proper position, install bolts and fix them, and check to ensure that the lamp is firmly installed.
- 3) Connect with the main supply according to the instruction.

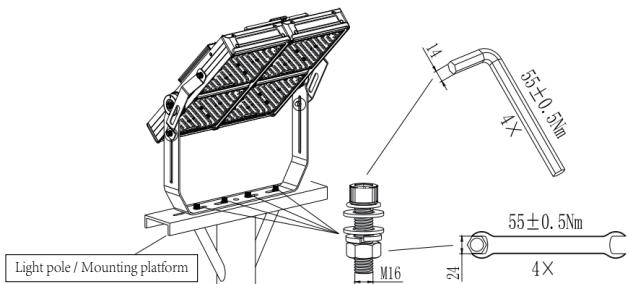
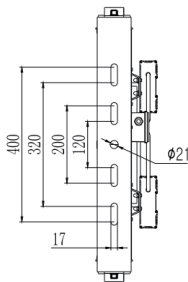

Dimensional Drawing of Bracket.

Put the lamp in a proper position, install bolts and fix them.

Connect to the main supply

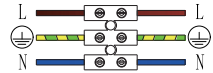
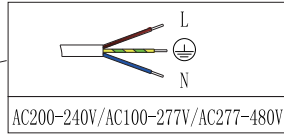
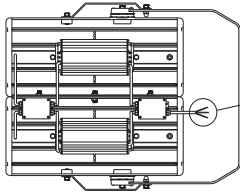

L	Brown / Black
N	Blue / White
	Yellow Green / Green

Remote version installation instructions

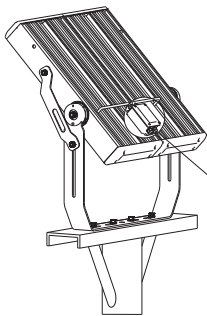

Mounted the lamp on a pole and confirm firmness

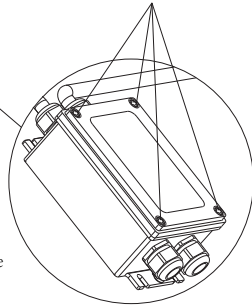
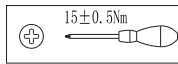

Open the cover of junction box

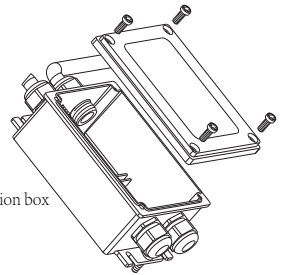

Junction box on the back of the light

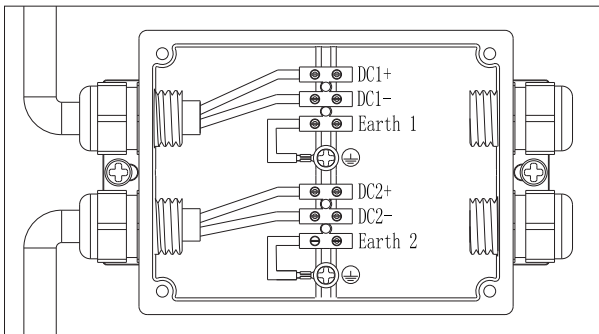

Recommended section cable diameter for connecting to the junction box between $\phi 9$ - $\phi 12$, $\phi 12$ Max.

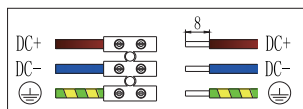
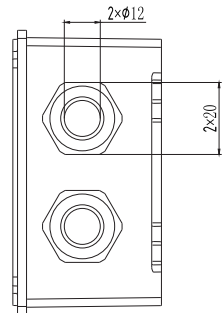

DC+	Brown
DC-	Blue
	Green and Yellow

Junction box on the back of the light

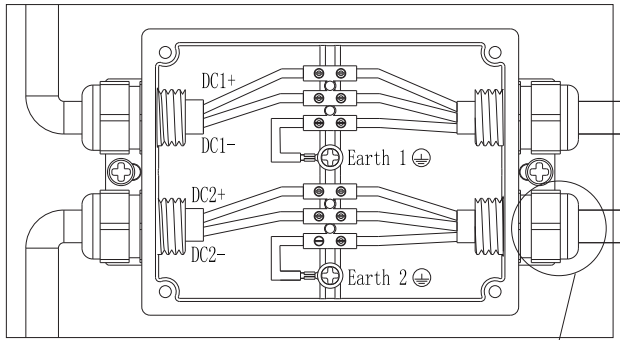

The length of this cable is the distance from the junction box on the back of the lamp to the driver near the ground end.

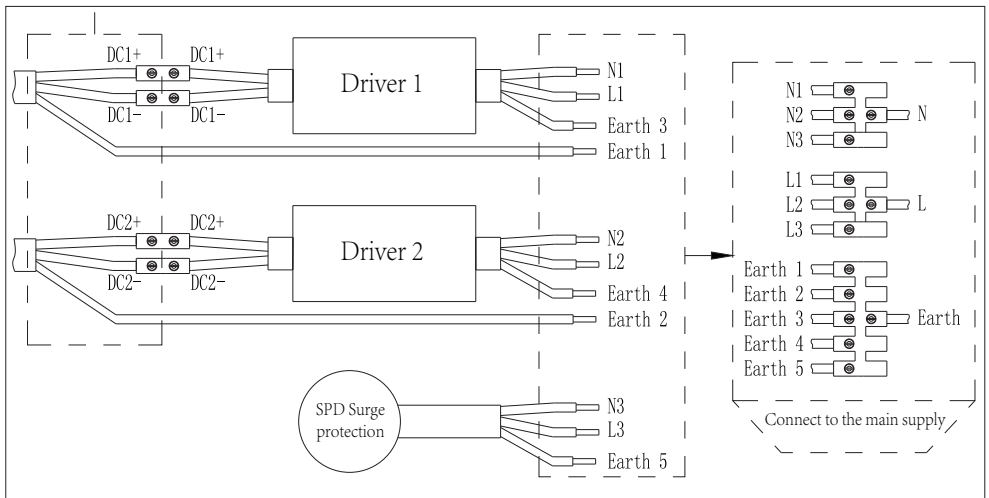
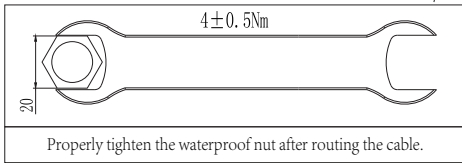
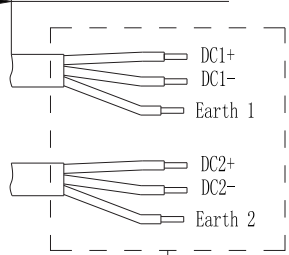

Ground end power junction box

Flood Light Bottom Bracket Installation Dimensions

400W/500W、800W、1200W

1600W、2400W

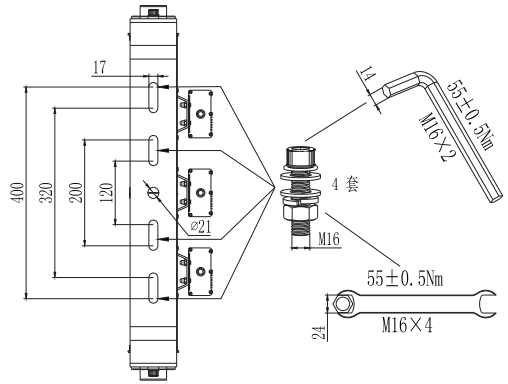
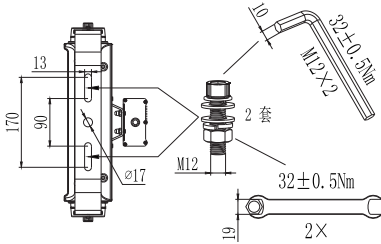

Angle adjustment instructions:

1) Loosen the bolts as indicated below. 2) Adjust the beam angle. 3) Re-tighten the bolts.







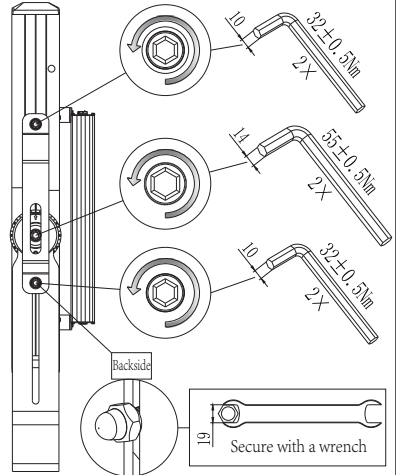
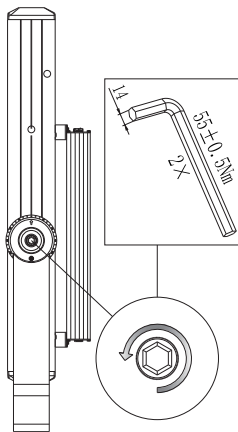
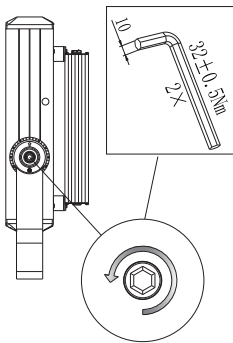





400W/500W

800W、1200W

1600W、2400W



Warning

-  Connect the power according to the installation instructions and related regulations!
-  Installation requires the guidance of relevant qualified personnel!
-  The luminaire must be grounded and the voltage used must not exceed the specified value!
-  Never operate the lamp when voltage is present on the lamp!
-  Please note that the installation location can support the luminaire, otherwise it will cause a fall hazard!
-  Do not apply impact force to lamps, lens, etc. to avoid falling and lens damage!
-  Do not change or replace parts of the luminaire to avoid accidents such as falling, electric shock, fire, etc.!
-  When the lamp is turned on, it is forbidden to look directly at the lamp at a short distance to avoid eye damage!
-  When the lamp is turned on, it will generate high temperature, please do not touch it to prevent burns!
-  If the luminaire fails, please contact the manufacturer or service partner!
-  Damaged connection cables must be replaced by the manufacturer or service partner!
-  Do not use the luminaire outside of its permissible ambient temperature range, exceeding the range will reduce the service life!